

Click to Download

— For Your WHEEL HORSE of Course —

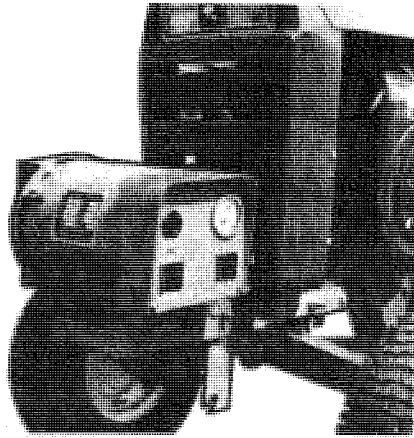

AC ALTERNATOR

Manufactured By:
GENERAL CORP.
 P. O. Box 8
 WAUKESHA, WISCONSIN 53186

Write to Above Address for Replacement
 Parts and/or Warranty.

PRICES EFFECTIVE: 3/1/70

Select the Proper Unit for Your Requirements

In choosing the correct size alternator add up the wattage of the total connected load. With lights, heaters and power tools add nameplate ratings. See table for power tool wattage requirements.

Equipment	Watts
6" Hand Saw	1000
3/4" Electric Drill	750
14" Chain Saw	1000
8 1/2" Hand Saw	1500
1" Electric Drill	1000
Toaster (2 slice)	1050
10" Hand Saw	2000
3" Belt Sander	1000
Concrete Vibrator	2500
3/4" Electric Drill	250
Electric Fry-pan	1250
Sump Pump	1500-2000

Electric motors (except Universal Motors) require considerably more amperage to start than is required for running. To establish wattage for electric motors check the nameplate for rating and type, then refer to the "Motor Load" table.

Motor HP Rating	Approx. Running Watts	Watts Required to Start		
		Repul. Induc.	Capac. Type	Split Phase Type
1/6	275	600	850	1200
1/4	400	850	1050	1700
1/3	450	975	1350	1950
1/2	600	1300	1800	2600
3/4	850	1900	2600	
1	1100	2500	3400	

Repulsion Induction motors allow 2000 watts per HP for average load conditions. Capacitor start motors above 1 HP — allow 3300 watts per HP. Three-phase motors — allow 1800 watts per HP.

ALTERNATORS

Order No.	Model No.	Watts	Volts	Amps	RPM	Weight	Suggested List Price
AP386	5678	2400	115	17.5	3600	35	\$168.00
AP387	5679	4000	115	34.8	3600	80	229.00
			230	17.4			

MOUNTING KITS FOR WHEEL HORSE

Order No.	Model	Year	H.P.	Suggested List Price
AP388	5795	1968-69-70-71	10-12	\$20.00
AP399	5808	1969-70-71	GT-14	30.00

DELIVERY: 2 Weeks Under Normal Conditions.

Prices F.O.B. Waukesha, Wisconsin.

Prices, Terms, Specifications, Subject To Change Without Notice.

July 1970 — ALLIED ATTACHMENTS

— For Your WHEEL HORSE of Course —

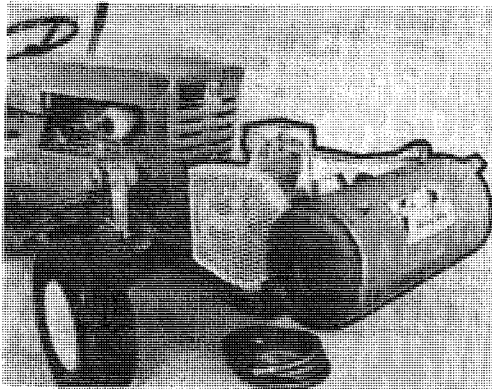

AIR COMPRESSOR

Manufactured By:
FLITEWAY SALES, INC.
 HORICON WISCONSIN

Write to Above Address for Replacement
 Parts and/or Warranty

PRICES EFFECTIVE: 3/1/70

FEATURES

TANK — Hydrostatically and safety tested to 300 PSI. Actual rupture point 900 PSI. Automatic machine welded.

PUMP — Ball bearing twin cylinder. Honed cylinder for maximum efficiency. Every item run-in at factory. Balanced precision made internal parts for smooth quiet operation. Filtered air intake. Stainless steel valves. Positive splash lubrication. Three ring piston for long trouble-free life. Dip stick oil check.

PILOT VALVE — Unloads at 125 PSI. Begins recovery at 100 PSI.

SAFETY RELIEF VALVE — Set at 135 PSI.

AIR HOSE — 18 foot Heavy Duty Oil Resistant with air chuck.

SHUT OFF VALVE.

GAUGE — 0-200 pounds.

FINISH — Attractively painted Red to match Wheel Horse tractor. Guard painted white.

Order No.	Model	Description	Weight	Suggested List Price
AP301	108WH	Air Compressor -- Tractor Mounted 100-125 Lbs. Pressure Range	80	\$165.00

Specify Model and Year of Tractor when ordering.

DELIVERY: 2 Weeks Under Normal Conditions.

Prices F.O.B. Horicon, Wisconsin.

Prices, Terms, Specifications, Subject To Change Without Notice.

July 1970 — ALLIED ATTACHMENTS

— For Your WHEEL HORSE of Course —

FRONT END LOADER

Manufactured By:
ARK MANUFACTURING CO.
P. O. Box 327
STERLING, KANSAS 67579

Write to Above Address for Replacement
Parts and/or Warranty.

PRICES EFFECTIVE: 8/1/70

Model 510

Clearance under bucket fully
dumped 57"
Clearance under fully raised bucket 78"
Height to pivot fully raised 76½"
Reach with bucket fully dumped ... 29"
Clearance from grille to bucket ... 27"
Degrees dumping angle 54°
Bucket payload capacity 480-500 lbs.
Basic loader weight 275 lbs.

The ARK HYDRAULIC LOADER is truly a quality-built product. Professionalism in design has been coupled with operational flexibility for maximum use in the field. For example, the people from ARK have equipped all units with a third detent in the lift side of the control to allow the operator to "float" the entire loader if he needs to follow the contour . . . or he may use the float for lowering the bucket while moving the tractor. Double acting hydraulic cylinders are used both on the lift and bucket tilt . . . with chrome plated shafts for long life and outstanding service. The hydraulic system is independent of the tractor and may be used to operate other ARK accessories as well.

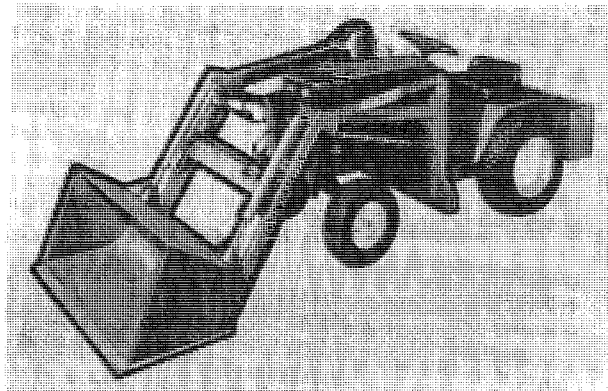

Model 508

49½" — Clearance under bucket fully dumped.
71½" — Clearance under fully raised bucket.
70½" — Height to pivot fully raised.
23" — Reach with bucket fully dumped.
22½" — Clearance from grille to bucket.
54 degrees dumping angle.

Double acting 2" cylinders on lift arms and two double acting 1½" hydraulic bucket dump cylinders. Bucket capacity — 350 lbs. payload.

Continued →

— For Your WHEEL HORSE of Course —

ARK LOADERS
(Continued)

Order No.	Model	Description	Weight	Suggested List Price
AP307	508	Ark 500 Series Loader w/Dual Hydraulic Tilt (For 10 and 12 HP Long Frame Models)	233	\$523.00
AP308	510	Ark 500 Series Loader w/Dual Hydraulic Tilt (GT-14 Only)	275	560.00

SPECIFY: Type A mountings for loader operation only.
Type B mountings for loader, mower or tiller
Combination (GT-14 Only)

All Ark series 500 loaders are equipped with two (2) double acting lift cylinders; two (2) double acting tilt cylinders, complete with mounting brackets, hydraulic kit including pump, control valve hydraulic hoses and fittings. Control valve is equipped with a third detent or float position in the lift control.

Please Specify If Tractor Has Electric Clutch

IMPORTANT: Ballast box is necessary unless wheel weights are to be used on tractor.

ATTACHMENTS FOR ARK 500 SERIES LOADERS:

Order No.	Model	Description	Weight	Suggested List Price
AP309	28040	40" Material Bucket	86	\$64.50
AP310	28048	48" Material Bucket	98	77.00
AP311	28060	60" Material Bucket	114	93.75
AP312	28100	40" Tine Fork	65	65.00
AP313	28200	Front Mounted Boom	25	30.00
AP314	28300	Pallet Fork	92	73.50
AP315	29800	Ballast Box	52	30.00
AP316	29880	Ballast Box for GT-14	52	30.00

DELIVERY: 2 Weeks Under Normal Conditions.

Prices F.O.B. Sterling, Kansas.

Prices, Terms, Specifications, Subject To Change Without Notice

July 1970 — ALLIED ATTACHMENTS

— For Your WHEEL HORSE of Course —

**ANGLE BROOM
SWEEPER**

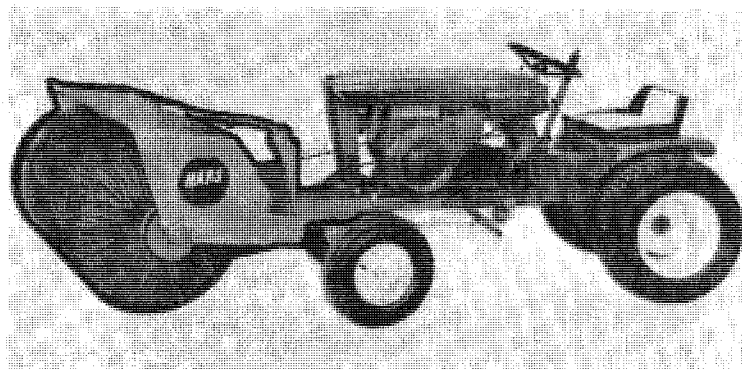

Manufactured By:
MARS INDUSTRIES, INC.
5209 N. Broadway
MINNEAPOLIS, MINNESOTA 55429

Write to Above Address for Replacement
Parts and/or Warranty.

PRICES EFFECTIVE: 6/1/70

The MARS ANGLE BROOM is designed for fast, effective sweeping jobs such as sidewalk and drive way sweeping, grass, leaves, clean-up and snow removal. It's easy to operate: Start the tractor, engage the clutch, lower the broom and start sweeping. Swath clears front, rear tire tracks.

TYPICAL APPLICATIONS

HOME OWNER
SCHOOLS AND INSTITUTIONS
SHOPPING AREAS
COUNTRY CLUBS
ESTATES

PARKING AREAS
PARK BOARDS
DRIVE IN THEATRES
CEMETERIES
RENTAL STORES

FEATURES

PTO Direct Belt Drive.
All welded steel construction with NEW non clog design hood.
Easy on, easy off mounting brackets.
Long lasting synthetic fibre broom standard.
Standard self-aligning bearings, sprocket, pulleys and chain.

Order No.	Model	Description	Weight	List Price
AP367	S-44EWH	(GT-14 Only) Rotary Sweeper Attachment	260	\$420.00
AP368	S-44	Rotary Sweeper Attachment (10-12 HP)	200	325.00
AP369	EB	Extra Broom for S-44 Sweeper	63	132.00
AP370	444AF	Pick-Up Sweeper — 7 cu. ft. Hopper	550	570.00

NOTE: Specify Model and Year of Tractor when ordering.

DELIVERY: 2 Weeks Under Normal Conditions.

Prices F.O.B. Minneapolis, Minnesota.

Prices, Terms, Specifications, Subject To Change Without Notice.

July 1970 — ALLIED ATTACHMENTS

— For Your WHEEL HORSE of Course —

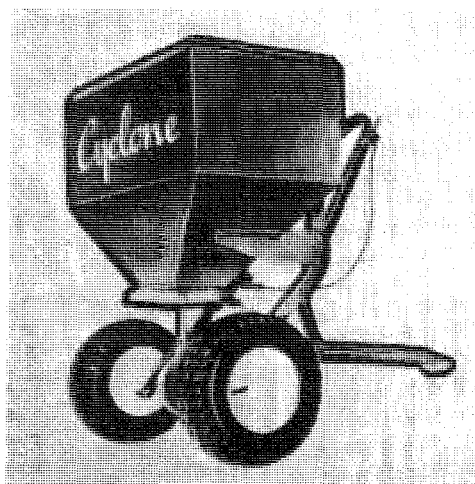

**SEEDER SPREADER
(Rotary)**

Manufactured By:
CYCLONE SEEDER, INC.
URBANA, INDIANA

Write to Above Address for Replacemen
Parts and/or Warranty.

PRICES EFFECTIVE: 10/10/69

Specifications

HOPPER -- Heavy gauge galvanized steel, baked-on enamel finish.
Capacity, 100 lbs.

FRAME -- Square tubular construction. Baked enamel finish.

AGITATOR -- Patented stainless steel rotary agitator plus vibrating
feed opening for smooth flow.

RATE CONTROL -- Famous Cyclone Micro-Dial.

ALL BEARINGS -- Corrosion-proof, durable nylon.

WHEELS -- Heavy duty steel wheels -- 12-5 x 4.50 pneumatic tires on
both Models 99 and 100.

GEARS -- Precision die cast, enclosed in cast aluminum gear box.

SHIPPING WEIGHT -- Model 99 - 55 lbs.; 100 - 49 lbs.

DIMENSIONS -- 21½" Overall width --
33½" Overall height.

Order No.	Model	Description	Weight	List Price
AP306	#99	Cyclone Broadcast Spreader-Seeder Tow Unit with Draw-Bar Hitch	55	\$97.50

DELIVERY: 2 Weeks Under Normal Conditions.

Prices F.O.B. Urbana, Indiana.

Prices, Terms, Specifications, Subject To Change Without Notice.

July 1970 -- ALLIED ATTACHMENTS

— For Your WHEEL HORSE of Course —

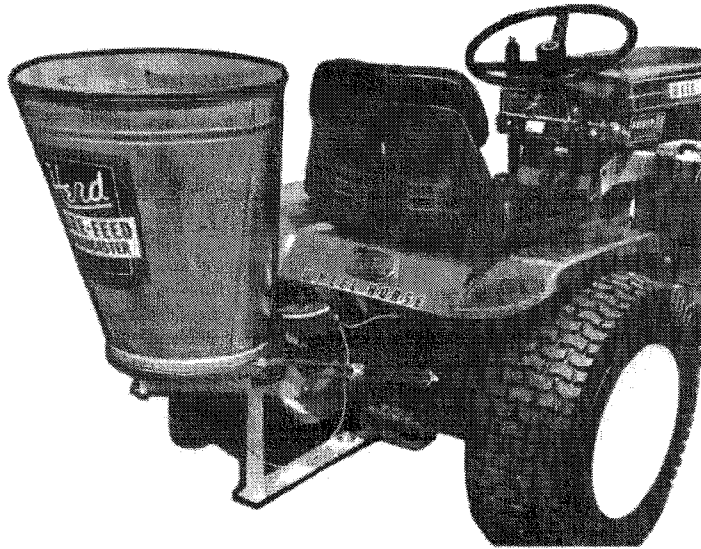

BROADCAST SEEDER
(ELECTRIC, 12 VOLT)

Manufactured By:
HERD SEEDER CO., INC.
LOGANSPORT, INDIANA 46947

Write to Above Address for Replacement
Parts and/or Warranty.

PRICES EFFECTIVE: 4/30/70

Order No.	Model	Description	Weight	Suggested List Price
AP324	GT-77	Sure-Feed Electric Broadcast Spreader (Cap. 38 qt. or 77 lbs.) Includes, Rheostat, Wiring Harness and Mounting Brackets	Approx. 90	\$96.50

DELIVERY: 2 Weeks Under Normal Conditions.

Prices F.O.B. Logansport, Indiana.

Prices, Terms, Specifications, Subject To Change Without Notice.

July 1970 — ALLIED ATTACHMENTS

— For Your WHEEL HORSE of Course —

**SPRAYER
(TRACTOR MOUNTED)**

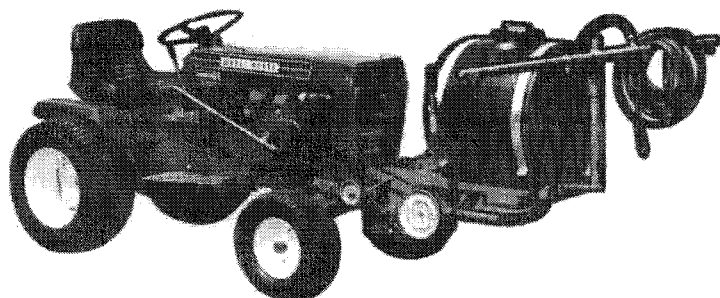

Manufactured By:
AMERIND-MAC KISSIC, INC.
Box 111
PARKER FORD, PENNSYLVANIA 19457

Write to Above Address for Replacement
Parts and/or Warranty.

PRICES EFFECTIVE: 9/1/69

WH-TS

Specifications

Overall Width 21"
Overall Length 29"
Overall Height 32"
Shipping Weight 95 lbs.

MODEL No. WH-TS — For Wheel Horse Tractors

Mounts to all Wheel Horse garden tractors 10, 12 HP-1966 through 1971 including 1971 Bronco 14. Ideal for spraying fruit and shade trees, shrubbery, gardens, lawns. Spray bar attachment available to cover 80" wide path for liquid fertilizer treatment of gardens.

22 gallon polyethylene tank, large fill hole. Line return from control valve enters tank and provides constant agitation of spray liquid or wettable powders. Line strainer aid in preventing spray nozzles from clogging.

3 gallons per minute at 300 psi provides penetrating spray into heavy green growth, trees or shrubbery alike. Handles all common insecticides, fungicides, weed killers — even whitewash. Complete with relief valve, hand spray gun, 25 feet of pressure hose as standard. Larger spray hand nozzle available. Additional 25' of hose optional. Quickly mounts to your tractor.

Model No.	Order No.	Description	Suggested List Price
AP302	WH-TS	Estate Sprayer (Fits All Long Frame Tractors)	\$211.00
AP303	SB	Spray Broom For WH-TS Sprayer	42.00
AP304	EH	Extra 25' High Pressure Hose w/Fittings	16.50

ALWAYS SPECIFY MODEL & YEAR OF TRACTOR

DELIVERY: 2 Weeks Under Normal Conditions.

Prices F.O.B. Parker Ford, Pennsylvania.

Prices, Terms, Specifications, Subject To Change Without Notice.

July 1970 — ALLIED ATTACHMENTS

— For Your WHEEL HORSE of Course —

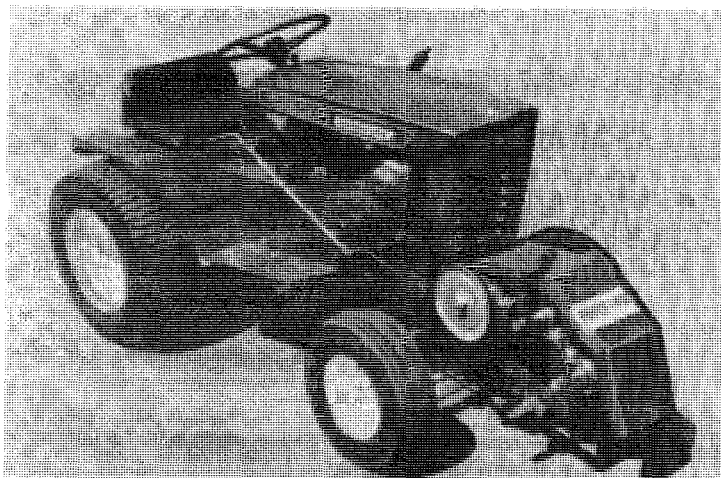

MULTI-SPEED PTO

Manufactured By:
FAIRBURY PRODUCTS, INC.
P. O. Box 117
ANCHOR, ILLINOIS 61720

Write to Above Address for Replacements
Parts and/or Warranty.

PRICES EFFECTIVE: 3/1/70

You'll find many new jobs for your tractor with Power-Twist

Here's the multi-speed power take-off which turns your compact tractor into a versatile, portable power source. Free your field tractor for bigger jobs and gain a reliable standby source for emergency power. Attaches with just 2 bolts to front hitch supplied; detaches easily and hitch forms tractor bumper. Single heavy-duty, industrial V-belt drives PTO. Unit is all steel — roller bearing pillow blocks fitted with grease zerks assure quiet operation. Drive shafts are hardened steel turning in sealed bearing. Easily handles 50' grain augers, hopper elevators, pumps, conveyor belts, flex shaft tools, generator many others. Start using your tractor year 'round with Power-Twist.

SPEED RANGE and SPINDLE SIZES

- 1000 RPM — 21 spline shaft Grain Augers
 - 540 RPM — 6 spline shaft Grain Augers
 - 175 RPM — 1" square shaft/Hopper Elevators — Fits U-Joints
- 1750 RPM also available when extra coupling is fitted to idler shaft.
Powers grinders, drills, other tools.

Order No.	Model	Description	Weight	Suggested List Price
AP394	80WH	Power Twist — Multi-Speed PTO 1000 RPM — 540 RPM — 175 RPM	---	\$164.00

DELIVERY: 2 Weeks Under Normal Conditions.
Prices F.O.B. Anchor, Illinois.
Prices, Terms, Specifications, Subject To Change Without Notice.

— For Your WHEEL HORSE of Course —

GANG REEL MOWERS

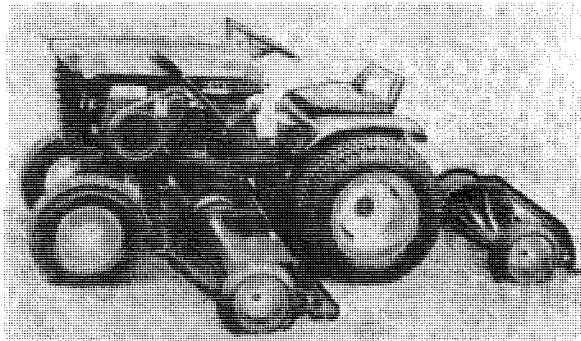

Manufactured By:
ROXY-BONNER, INC.
2002 Pioneer Road
HUNTINGTON VALLEY, PA. 19006

Write to Above Address for Replacement
Parts and/or Warranty.

PRICES EFFECTIVE: 11/1/69

ROXY LAWSHEAR MOWERS FOR USE WITH WHEEL HORSE LAWN AND GARDEN TRACTORS

MODEL UM21-3W cuts 56"-58" and exclusive Roxy Undermount minimizes wheel tracks. Approved for all WHEEL HORSE Standard Chassis Tractors. All 21" mower units have 6 $\frac{3}{4}$ " diameter reels, $\frac{3}{4}$ " diameter shafts, 2 $\frac{7}{8}$ " diameter steel rollers. Height of cut is adjustable — 1 $\frac{1}{4}$ " to 2 $\frac{1}{8}$ ". Speed — 3 to 5 m.p.h. can go faster, but 4 m.p.h. is best. Pinion gear and pawl drive same as on heavier units described on other side.

Order No.	Model	Description	Weight	Suggested List Price
AP364	MR21-3G	60" Cut, 3 Gang Drag, Pull Type, with Hitch — Fits All Wheel Horse Tractors	265	\$312.00
AP365	UM21-3W	56"-58" Cut, 3 Gang Under Mounted Mower, Including Hitch, For All Wheel Horse LONG FRAME Tractors Only	287	336.00

DELIVERY: 2 Weeks Under Normal Conditions.
Prices F.O.B. Huntington Valley, Pennsylvania.
Prices, Terms, Specifications, Subject To Change Without Notice.

July 1970 — ALLIED ATTACHMENTS

— For Your WHEEL HORSE of Course —

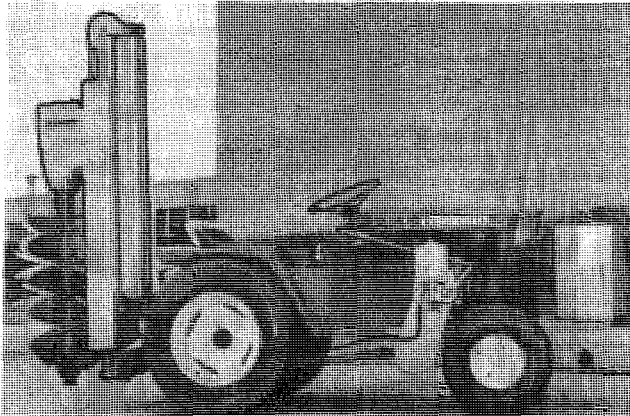

**POST-HOLE DIGGER
(GT-14 ONLY)**

Manufactured By:
DANUSER MACHINE CO.
FULTON, MISSOURI

Write to Above Address for Replacement
Parts and/or Warranty.

PRICES EFFECTIVE: 7/1/70

A commercial and light industrial hole digger quality engineered and built by the world's largest manufacturer of earth drilling equipment for use with the WHEEL HORSE tractors, and other makes of tractors of same basic design. As an owner or contractor it's designed to increase your profits. The Danuser Compact Digger is job rated for every requirement.

Order No.	Model	Description	Weight	Suggested List Price
AP376	CD-1	(8100) Digger — Less Adaptor Package — Less Auger	279	\$376.90
AP377	9211	Wheel Horse GT-14 Adaptor Package	104	316.80
AP378	8324	4" Auger — Plain Edge	20	35.36
AP379	8116	6" Auger — Plain Edge	31	39.50
AP380	8115	9" Auger — Plain Edge	39	44.46
AP381	8119	10" Auger — Plain Edge	46	46.48
AP382	8327	12" Auger — Plain Edge	52	50.48
AP383	8113	14" Auger — Plain Edge	59	54.50

NOTE:

(To arrive at complete digger price, take digger \$ _____ + adaptor kit \$ _____
+ auger size \$ _____ = total list price.)

DELIVERY: 2 Weeks Under Normal Conditions.

Prices F.O.B. Fulton, Missouri.

Prices, Terms, Specifications, Subject To Change Without Notice.

July 1970 — ALLIED ATTACHMENTS

— For Your WHEEL HORSE of Course —

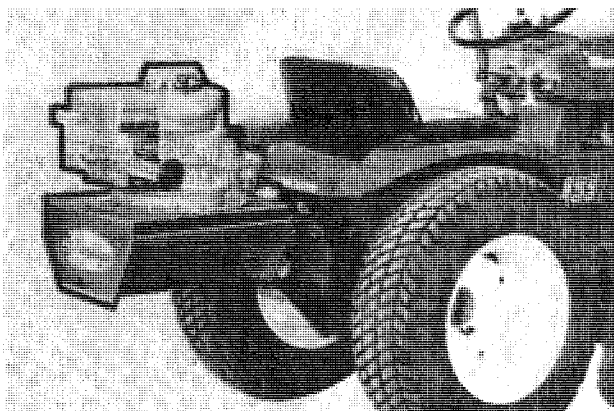

INSECT FOGGER

Manufactured By:
CENOL COMPANY, INC.
3240 W. Chicago Avenue
CHICAGO, ILLINOIS 60651

Write to Above Address for Replacement
Parts and/or Warranty.

PRICES EFFECTIVE: 2/1/70

Specifications

- TYPE:** Thermal Aerosol Fogger using friction disc principle.
Insecticide tank capacity — 3.5
Maximum pumping pressure — 20 psi
- MICRON SIZE:** — from 0 to 80 microns (average size: 15 microns)
- FOGGING RATE:** — 0 to 5 gallons per hour
- FORMULATIONS:** — Insecticides, pesticides, deodorizers, and other oil base materials
- WEIGHT:** empty: 37 lbs.
- WEIGHT:** full: 61 lbs.
- HEIGHT:** 18 inches
- LENGTH:** 14½ inches
- WIDTH:** 13½" inches

Powerful unit can produce about 22,000 cubic feet of insect-killing fog per minute. Acts instantly without warm-up. Equipped with 3 hp 4-cycle Briggs and Stratton engine. Positive on-off and variable speed controls. 3.5 gallon insecticide tank capacity.

Order No.	Model	Description	Weight	Suggested List Price
AP395	F-2205	3 H.P. Tractor Fogger	62	\$195.00
AP396	M-B	Mounting Bracket for Tractor Fogger	10	33.00

DELIVERY: 2 Weeks Under Normal Conditions.
Prices F.O.B. Chicago, Illinois.
Prices, Terms, Specifications, Subject To Change Without Notice.

July 1970 — ALLIED ATTACHMENTS

— For Your WHEEL HORSE of Course —

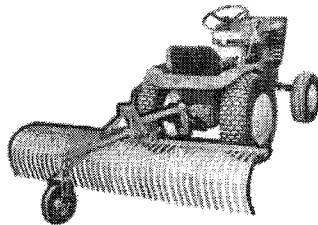

**MINI-BLADE
AND
MINI-RAKE
(REAR MOUNT)**

Manufactured By:
ARPS CORP.
NEW HOLSTEIN, WISCONSIN 53061

Write to Above Address for Replacement
Parts and/or Warranty.

PRICES EFFECTIVE: 1/1/70

ARPS MINI-BLADE

SPECIFICATIONS

Moldboard Height	13"
Moldboard Length	4'
Moldboard Thickness	3/16"
Radius of Moldboard Curvature	12"
No. of Angle Positions, Forward and Rear Travel	5
Offset	8 1/2"
Weight (Approx.)	85 lbs.
Accessories Available	Side Plates, Single Gauge Wheel

ARPS MINI-RAKE

SPECIFICATIONS

Rake Lengths	4' and 6'
Distance Between Rake Teeth	1"
No. of Angle Positions	5
Hitches	Drawbar Slot
Weight (Approx.) 4' Rake	75 lbs.
Available Accessories	Single Gauge Wheel

Order No.	Model	Description	Weight	Suggested List Price*
AP319	UB51A	48" "Mini" Rear Rake, Complete Including Frame (M59) and Frame Adaptor (M90) (GT-14 Only)	70	\$ 88.00
AP320	UB52A	72" "Mini" Rear Rake, Complete Including Frame (M59) and Frame Adaptor (M90) (GT-14 Only)	92	116.25
AP321	M10	48" Arps "Mini" Rear Blade and Frame Ass'y. (GT-14 Only)	80	69.00
AP322	M70A	48" "Mini" Rear Blade and Frame (M-10) and Adaptor (M-85) for W.H. Tractors with Slot Type Hitch	85	77.50
AP323	UB71A	48" "Mini" Rear Rake, Complete Including Frame (M-59) Rake (M-22) and Frame Adaptor (M-90) and Adaptor (M-85) for W.H. Tractors with Slot Type Hitch	75	96.50

*Short Dealer Discount

DELIVERY: 2 Weeks Under Normal Conditions.

Prices F.O.B. New Holstein, Wisconsin.

Prices, Terms, Specifications, Subject To Change Without Notice.

July 1970 — ALLIED ATTACHMENTS

— For Your WHEEL HORSE of Course —

SEEDER SPREADER

Manufactured By:
O. M. SCOTT & SONS
MARYSVILLE, OHIO 43040

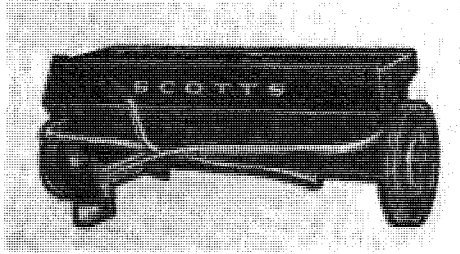

Write to Above Address for Replacement
Parts and/or Warranty.

PRICES EFFECTIVE: 7/15/70

716-T

Order No.	Model No.	Description	Weight	Suggested List Price
AP325	720-T	Broadcast Spreader	30	\$54.95
AP326	716-T	36" Tractor Drawn Spreader	50	54.95
AP327	H. A.	Hitch Adaptor for W./H.		2.50

STOCK ITEM

Prices F.O.B. Kansas City or Dallas Warehouse.
Prices, Terms, Specifications, Subject To Change Without Notice.

July 1970 — ALLIED ATTACHMENTS

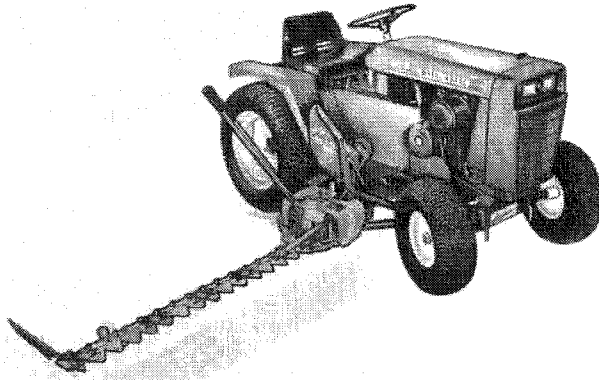

SICKLE BAR MOWER

Manufactured By:

HABAN MANUFACTURING CO.
RACINE, WISCONSIN

Write to Above Address for Replacement
Parts and/or Warranty

PRICES EFFECTIVE: 5/1/70

The new HABAN SICKLE BAR MOWER has many unusual features. It is fitted with a special type of cutting unit that handles the toughest growth without clogging, and new shear fingers of high carbon steel designed to offer continuous shearing action throughout the stroke of the knife.

A unique and particularly valuable feature of the new HABAN SICKLE BAR is its full-floating action, self-adjusting the cutter bar angle to ground contour. The bar can be lever-adjusted to mow at any angle from 45° below horizontal to nearly 90° vertical. This provides quick adjustment for steep banks or inclined road shoulders, and permits using the HABAN even for trimming the sides of hedges, brush and bushes. A special pin-lock in the elevating lever provides quick security in vertical transport position.

MOUNTING POINTS	Unit is suspended from tractor front axle with two mounting clamps -- rear mounting includes vibration dampener. Unit can be installed or detached from tractor without wrenches after initial installation.
COLOR	Mounting parts red; mowing unit white.
INSTALLATION TIME	First installation including setup of unit, adjusting V-belt, drive, etc. -- 45 to 90 minutes.
INSTALLATION TIME AFTER INITIAL SETUP	10 minutes.
DETACHING UNIT FROM TRACTOR	5 minutes or less -- simply remove six clevis pins and PTO drive belt.
WIDTH OF CUT	48" swath.

Order No.	Model	Description	Weight	Suggested List Price
AP366	41401	Sickle -- No Unit for GT-14 and All 10, 12 & 14 H.P. Tractors 1969 & Later	230	\$255.00

DELIVERY: 2 Weeks Under Normal Conditions.

Prices F.O.B. Racine, Wisconsin.

Prices, Terms, Specifications, Subject To Change Without Notice.

July 1970 -- ALLIED ATTACHMENTS

— For Your WHEEL HORSE of Course —

PULL-TYPE THATCHER

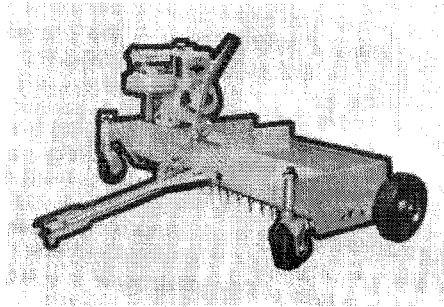

Manufactured By:
E-Z RAKE, INC.
1001 S. Ransdale Road
LEBANON, INDIANA 46052

Write to Above Address for Replacement
Parts and/or Warranty.

PRICES EFFECTIVE: 1/1/70

Lawn and golf course experts agree —

Thatch removal permits better lawn aeration and irrigation; improves fertilizer and seed response; cuts maintenance costs. Thatch removal gives grass room to grow; reduces likelihood of fungus and insects; reduces "dry spots." E-Z Rake makes healthy lawns smother weeds!

- Easy and quick to attach and remove)
- Ruggedly built
- 100 strong, rubber sleeved, spring tines
- Steerable front casters — 5" hard rubber wheels
- 14 gage steel deck; 3/8" steel end plates
- Integral engine drive
- Full 27½" raking width

Order No.	Model	Description	Weight	Suggested List Price
AP384	100M	Thatcher, Complete, For Mechanical Lift Tractor, Front Mounted	129	\$185.00
AP385	100H	Thatcher, Complete, For Hydraulic Lift Tractor, Front Mounted	150	185.00
AP392	110	PULL TYPE Thatcher, Complete	135	225.00

DELIVERY: 2 Weeks Under Normal Conditions.
Prices F.O.B. Lebanon, Indiana.
Prices, Terms, Specifications, Subject To Change Without Notice.

July 1970 — ALLIED ATTACHMENTS

— For Your WHEEL HORSE of Course —

POWER SPRAYER

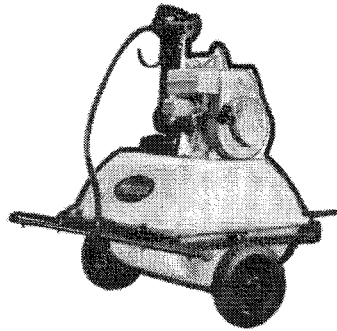

Manufactured By:
HANSON EQUIP. CO.
 301 Charles Street
 SOUTH BELOIT, ILLINOIS 61080

Write to Above Address for Replacement
 Parts and/or Warranty.

PRICES EFFECTIVE: 2/27/70

SPRAY-KING sprays any time — any place! Takes no more time to set up than it takes to hitch to your tractor . . . fast and easy to convert from boom sprayer to hand gun . . . takes the muss, fuss and labor out of all your spraying jobs!

- NO-RUST FIBERGLASS TANK — 24-GALLON CAPACITY
- BRASS PRESSURE CONTROL, corrosion resistant.
- BRASS HAND GUN.
- CHEMICAL-RESISTANT HOSE.
- 6-ROLLER PUMP with ample capacity and pressure to handle all normal spring jobs around the home and garden.
- WEIGHT — Complete, 93 lbs.; Shipping Weight, 135 lbs.

Order No.	Model	Description	Weight	Suggested List Price
AP305	101516	Spray King Lawn & Garden Sprayer	135	\$296.00

DELIVERY: 2 Weeks Under Normal Conditions.
 Prices F.O.B. South Beloit, Wisconsin.
 Prices, Terms, Specifications, Subject To Change Without Notice.

July 1970 — ALLIED ATTACHMENTS

— For Your WHEEL HORSE of Course —

POWER SPRAYER

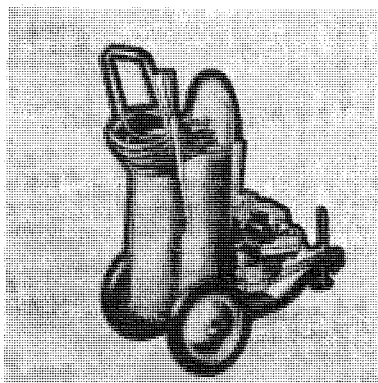

Manufactured By:
H. D. HUDSON CO.
 154 East Erie Street
 CHICAGO, ILL. 60611

Write to Above Address for Replacement
 Parts and/or Warranty.

PRICES EFFECTIVE: 9/2/69

**SAVE TIME AND WORK
 ON A DOZEN JOBS —
 NOT JUST ONE!**

- Banish weeds, disease, insects in lawn . . . apply fertilizer.
- Stop insects and disease on flowers, ornamentals, trees.
- Banish mosquitoes and other comfort-robbing insects in yard.
- Power-clean buildings, patio.
- Sanitize containers, kennels, etc.
- Fertilize shrubs and trees at roots or through leaves.
- Deep water shrubs and trees.
- Eradicate all vegetation where not wanted.
- Apply whitewash, shingle stain.
- Stop home-invading insects around foundation.
- Spray-coat ornaments to prevent freeze damage.
- Seal concrete to prevent salt damage.

SUBURBAN* TRAIL-N-SPRAY* SPRAYER

America's most popular yard and garden power sprayer. With 12½-gallon tank, pressure from 20 to 150 lbs., and output up to 2½-gallons per minute, the Trail-N-Spray handles any spraying chores from the lawn to 25-foot trees. Mechanical agitator keeps materials mixed; sprayer easily handles "tough" materials such as whitewash. The piston pump will give you years of dependable, trouble-free service. Other features include galvanized steel tank; 12" x 3" semi-pneumatic wheels; 4-cycle, 2-hp engine; 20 feet Kem-Oil hose with adjustable power gun. Hitches to any tractor.

Order No.	Model	Description	Weight	* Suggested List Price
AP317	42250	Suburban Trail-N-Spray	98	\$235.00
AP318	4250 DM	Suburban Trail-N-Spray Power Sprayer with Du-More Attachments	110	257.45

*Short Term Discount

DELIVERY: 2 Weeks Under Normal Conditions.

Prices F.O.B. Chicago, Illinois.

Prices, Terms, Specifications, Subject To Change Without Notice.

July 1970 — ALLIED ATTACHMENTS

— For Your WHEEL HORSE of Course —

VACUUM SWEEPER

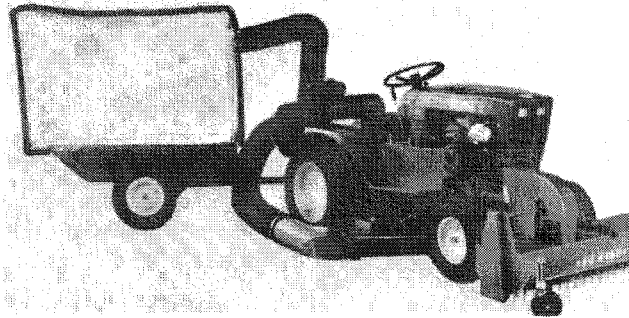

Manufactured By:
E-Z RAKE, INC.
 1001 S. Rosedale Road
 LEBANON, INDIANA 46052

Write to Above Address for Replacement
 Parts and/or Warranty.

PRICES EFFECTIVE: 1/1/76

- Effectively vacuums leaves, clippings, thatch and debris.
- Assures neat lawns — saves many man-hours of maintenance and clean-up.
- Easy to attach ... easy to use ... safe, quick, efficient.
- Patented reduction vent reduces bag pressure — increases suction efficiency.

Order No.	Model	Description	Weight	Suggested List Price*
AP399	40	Model 40 Vacuum Unit Consists of: 4 HP Engine, Boot Blower, Connecting Tube, Outlet Tube	145	\$312.50
AP400	C.C.	Cart Cover — Consists of: Frame and Hardware, Canvas Cover	30	50.00
AP401	30	Model 30 Vacuum Unit and Cart Consists of: 4 HP Engine, Connecting Hoses, Cart with Vent, Baffle, Hose Clamps, Fan Blade, Housing, Adaptor Boot, Hardware, Frame and Engine Mount	135	307.50
AP402	200	Vacuum Attachments — Fits Both Models. Consists of Pick-Up Vent with Handle, Hose, Clamp and Reducer	14	40.00

*Short Dealer Discount

DELIVERY: 2 Weeks Under Normal Conditions.

Prices F.O.B. Lebanon, Indiana.

Prices, Terms, Specifications, Subject To Change Without Notice.

July 1970 — ALLIED ATTACHMENTS