

481578
224-2500L

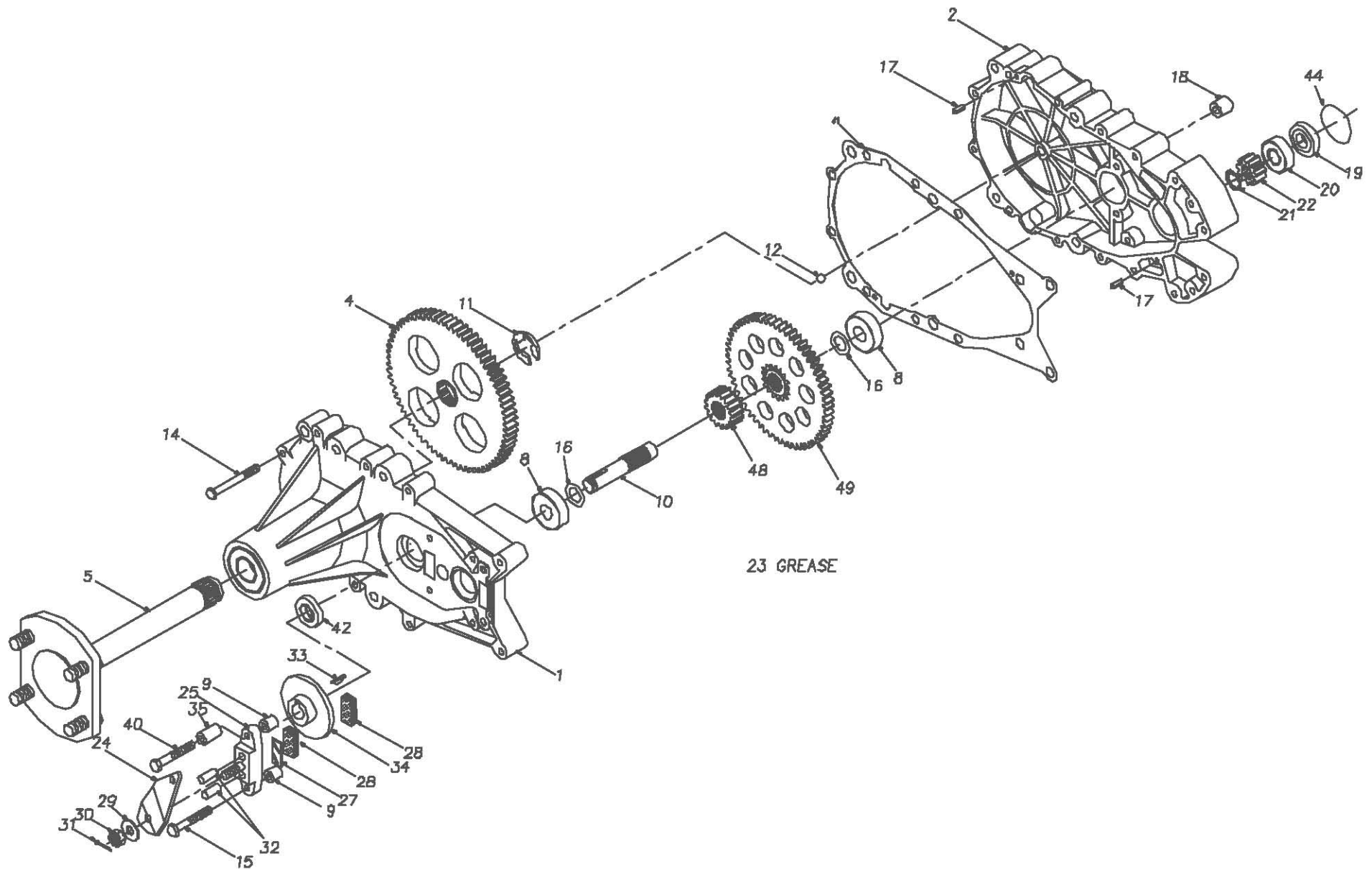

P.1 of 2. 70335-S1

481578
224-2500L

REF	PART NO.	QTY	DESCRIPTION
1	70318	1	ASS'Y, AXLE CARRIER HOUSING
		1	AXLE CARRIER HOUSING
		1	BALL BEARING, 52MM X 25MM X 15MM
		1	FLANGE BEARING
		1	OIL SEAL, 1.25 OD X .625 ID
		1	OIL SEAL, 52MM X 25MM
2	51004	1	HYDRO MOUNT HOUSING
4	44358	1	SPLINED 72 TOOTH FINAL DRIVE GEAR
5	62681	1	ASS'Y, AXLE
		1	AXLE SHAFT
		4	LUG BOLT
8	50625	2	BALL BEARING .625ID X 1.57 X .47
9	23770	2	BRAKE SPACER
10	44351	1	BRAKE SHAFT (SPLINED)
11	44359	1	E-RING
12	9001214-3700	1	BALL, 3/8" DIAMETER
15	44276	1	BOLT, 1/4-20 X 1-1/2"
14	44366	10	BOLT, 1/4-20 X 2-1/2"
16	50629	2	WASHER, 5/8ID X 1.0 OD X .01 THK
17	44269	2	PIN, SPRING 3/16" X 1/2" LONG
18	23749	2	MOUNTING SPACER
19	44355	1	BEARING SPACER
20	44232	1	BALL BEARING 15 MM X 35 MM X 11 MM
21	44354	1	RETAINING RING
22	44353	1	11 TOOTH INPUT GEAR
23	50416	2	GREASE(10 OZ TUBE)
24	44094	1	ARM, BRAKE ACTUATOR (LH ASSY)
25	62589	1	ASS'Y, BRAKE YOKE
		1	SQUARE HEAD BOLT
		1	BRAKE YOKE
27	44134	1	PLATE, PUCK
28	44132	2	PUCK, BRAKE
29	44130	1	WASHER, 7/16 X 7/8 OD X 0.06 HT
30	44142	1	NUT, CASTLE 5/16-24 PL
31	44101	1	PIN, COTTER
32	44127	2	PIN, BRAKE ACTUATING
33	44143	1	KEY, HI PRO 3/16 X 5/8
34	44090	1	DISC, BRAKE
35	23711	1	SPACER, TORSION SPRING
40	44612	1	BOLT, 1/4-20 X 2-1/2"
41	50223	1	GASKET, HSC
42	50283	1	OIL SEAL, 1.25 X .625
44	50267	1	O-RING
48	50419	1	17T GEAR
49	50420	1	60T GEAR

P.2 of 2. 70335-S1